

**THIS REPORT HAS BEEN EDITED BY
EXCELL RAILING SYSTEMS. FOR A
COPY OF THE ORIGINAL REPORT
CONTACT EXCELL RAILING SYSTEMS.**

REPORT NUMBER: 3155482COQ-002
ORIGINAL ISSUE DATE: August 25, 2008
REVISED DATE: October 22, 2008

EVALUATION CENTER
Intertek
1500 Brigantine Drive
Coquitlam, BC V3K 7C1

RENDERED TO

**EXCELL RAILING SYSTEM
#306 – 12886 ANVIL WAY
SURREY, BC V3W 8E7**

PRODUCT EVALUATED:
Excell Welded Picket & Glass Railing System and Durarail Welded Picket &
Glass Railing System
EVALUATION PROPERTY:
2006 International Building Code, Section 1607.7.1

**Engineering Evaluation of Excell Welded Picket & Glass Railing System
and Durarail Welded Picket & Glass Railing System for compliance with
the applicable requirements of the following criteria: 2006 International
Building Code, Section 1607.7.1**

ENGINEERING EVALUATION

This report is for the exclusive use of Intertek's Client and is provided pursuant to the agreement between Intertek and its Client. Intertek's responsibility and liability are limited to the terms and conditions of the agreement. Intertek assumes no liability to any party, other than to the Client in accordance with the agreement, for any loss, expense or damage occasioned by the use of this report. Only the Client is authorized to copy or distribute this report and then only in its entirety. Any use of the Intertek name or one of its marks for the sale or advertisement of the tested material, product or service must first be approved in writing by Intertek. The observations and test results in this report are relevant only to the sample tested. This report by itself does not imply that the material, product, or service is or has ever been under an Intertek certification program.

1 Introduction

Intertek has conducted an engineering evaluation for Excell Railing System, on the Excell Welded Picket & Glass Railing System and Durarail Welded Picket & Glass Railing System, to evaluate the interchangeability of 3 types of top rails. The evaluation was conducted to determine if the testing performed on the 2-piece round top rail, will show equivalency for the use of the other top rails in accordance with the 2006 International Building Code, Section 1607.7.1.

2 Sample and Assembly Description

Intertek has tested the following 2 railing systems in full accordance with the load requirements of the 2006 IBC, Section 1607.7.1:

System 1 – 6 ft. Durarail 2-Piece Round Welded Picket Railing System

Post: 1.72 in. x 1.72 in. 6061-T6 extruded aluminum post with a 6 in. 6061-T6 post insert

Base Plate (deck): 4 in. x 4 in. x 3/8 in. 6061-T6 aluminum base plate with 4 mounting holes

Top Rails: 42 in. high, 2-piece 6063-T5 aluminum round rail

Picket Insert: 5/8 in. x 5/8 in. 6063-T5 aluminum spaced 4-1/2 in. o/c

System 2 – 5 ft. Durarail 2-Piece Round Glass In-fill Railing System

Post: 1.72 in. x 1.72 in. 6061-T6 aluminum rail

Base Plate (deck): 4 in. x 4 in. x 3/8 in. 6061-T6 aluminum base plate with 4 mounting holes

Top Rails: 42 in. high, 2-piece 6063-T5 aluminum round rail

Panel Insert: ¼ in. thick tempered glass panel

The following systems have been evaluated to determine if they are equivalent to the systems above and would meet the requirements of the 2006 IBC, Section 1607.7.1:

System 3 – 6 ft. Durarail 2-Piece Square Welded Picket Railing System

- Post: 1.72 in. x 1.72 in. 6061-T6 extruded aluminum post with a 6 in. 6061-T6 post insert
- Base Plate (deck): 4 in. x 4 in. x 3/8 in. 6061-T6 aluminum base plate with 4 mounting holes
- Top Rails: 42 in. high, 2-piece 6063-T5 aluminum square rail
- Picket Insert: 5/8 in. x 5/8 in. 6063-T5 aluminum spaced 4-1/2 in. o/c

System 4 – 5 ft. Durarail 2-Piece Square Glass In-fill Railing System

- Post: 1.72 in. x 1.72 in. 6061-T6 aluminum rail
- Base Plate (deck): 4 in. x 4 in. x 3/8 in. 6061-T6 aluminum base plate with 4 mounting holes
- Top Rails: 42 in. high, 2-piece 6063-T5 aluminum square rail
- Panel Insert: ¼ in. thick tempered glass panel

System 5 – 6 ft. Excell 1-Piece Round Welded Picket Railing System

- Post: 1.72 in. x 1.72 in. 6061-T6 extruded aluminum post with a 6 in. 6061-T6 post insert
- Base Plate (deck): 4 in. x 4 in. x 3/8 in. 6061-T6 aluminum base plate with 4 mounting holes
- Top Rails: 42 in. high, 1-piece 6063-T5 aluminum round rail
- Picket Insert: 5/8 in. x 5/8 in. 6063-T5 aluminum spaced 4-1/2 in. o/c

System 6 – 5 ft. Excell 1-Piece Round Glass In-fill Railing System

- Post: 1.72 in. x 1.72 in. 6061-T6 aluminum rail
- Base Plate (deck): 4 in. x 4 in. x 3/8 in. 6061-T6 aluminum base plate with 4 mounting holes
- Top Rails: 42 in. high, 1-piece 6063-T5 aluminum round rail
- Panel Insert: ¼ in. thick tempered glass panel
-

System 7 – 6 ft. Excell 1-Piece Square Welded Picket Railing System

- Post: 1.72 in. x 1.72 in. 6061-T6 extruded aluminum post with a 6 in. 6061-T6 post insert
- Base Plate (deck): 4 in. x 4 in. x 3/8 in. 6061-T6 aluminum base plate with 4 mounting holes
- Top Rails: 42 in. high, 1-piece 6063-T5 aluminum square rail
- Picket Insert: 5/8 in. x 5/8 in. 6063-T5 aluminum spaced 4-1/2 in. o/c

System 8 – 5 ft. Excell 1-Piece Square Glass In-fill Railing System

- Post: 1.72 in. x 1.72 in. 6061-T6 aluminum rail
- Base Plate (deck): 4 in. x 4 in. x 3/8 in. 6061-T6 aluminum base plate with 4 mounting holes
- Top Rails: 42 in. high, 1-piece 6063-T5 aluminum square rail
- Panel Insert: ¼ in. thick tempered glass panel

Installation details of all 8 railing systems have been provided in Appendix A, along with specifications on each part.

3 Reference Documents

- 2006 International Building Code (2006 IBC)
 - Intertek Test Report 3155482COQ-001A
 - Intertek Test Report 3155482COQ-001B
 - System Drawings
 - Durarail Welded Picket System w/ 1.72" Posts
 - Durarail Glass System w/ 1.72" Posts
 - Excell Welded Picket System w/ 1.72" Posts
 - Excell Glass System w/ 1.72" Posts
-

4 Evaluation Method

Intertek Test Reports 3155482COQ-001A and 3155482COQ-001B for Systems 1 and 2 respectively showed that these systems meet the load requirements stated in Section 1607.7.1 of the 2006 IBC using a factor of safety of 2.5. A safety factor of 4 was applied on the in-fill test on the tempered glass panel in accordance with Section 2407.1.1 of the 2006 IBC. Based on the noted test results, the alternate systems mentioned in Section 2 of this report were evaluated for compliance in accordance with Section 1607.7.1 of the 2006 IBC.

Systems 3 and 4 are identical to Systems 1 and 2 in terms of the components being utilized in the railing system and the installation of the product, with 1 key difference. The top rail used in Systems 1 and 2 consists of a 2-piece round 6063-T5 aluminum rail as detailed in diagram VS-35977A, whereas Systems 3 and 4 use a 2-piece square 6063-T5 aluminum rail as detailed in VS-11725A (see Appendix). Comparing the moment of inertias (I_x , I_y) for both top rails as detailed in the noted drawings, the square top rail has greater I_x and I_y values than that of the round top rail. The maximum bending stress in the top rail is determined following the relationship noted in Equation 1 below.

$$\sigma = \frac{My}{I_n} \quad (\text{Equation 1})$$

Where σ = bending stress
 M = bending moment
 y = thickness / 2
 I_n = I_x or I_y

Between the round top rail and square top rail systems, for equivalent loads the bending stress experienced in the square top rail would be lower than that experienced by the round top rail. As the bending stress is the failure cause for the top rail, the lower stress experienced by the square rail for equivalent loads means Systems 1 and 2 tested in Intertek Test Report 3155482COQ-001A and 3155482COQ-001B would meet the requirements of Section 1607.7.1 of the 2006 IBC using the 2-piece square top rail detailed in Appendix Drawing VS-11725A.

Systems 5 and 6 are identical to Systems 1 and 2 in terms of all components being utilized in the railing system and the installation of the product with the exception of Systems 5 and 6 incorporating a round 1-piece top rail as opposed to the use of a round 2-piece top rail. The 1-piece round top rails for Systems 5 and 6 are detailed in diagram VH-40827 (see Appendix). Past testing at Intertek of this type of system showed that use of a 2-piece assembly did not allow the top rail and bottom channel to act as a composite section. The independent movement of the 2-piece top rail system decreases the lateral stiffness provided by the top rail to the railing system assembly, allowing greater deflection of the 2-piece top rail under equivalent loads compared to that of the 1-piece system. In addition, comparison of I_x and I_y for Systems 5 and 6 shows the 1-piece top rail for Systems 5 and 6 exceeds the I_x and I_y of Systems 1 and 2 detailed in VS-35977A. For the reasons noted above, Systems 1 and 2 from Intertek Test Report 3155482COQ-001A and 3155482COQ-001B would meet the requirements of Section 1607.7.1 of the 2006 IBC using the 1-piece round top rails detailed in Appendix Drawing VH-40827.

Systems 7 and 8 are identical to Systems 1 and 2 in terms of all components being utilized in the railing system and the installation of the product with the exception of Systems 7 and 8 incorporating a square 1-piece top rail as opposed to the use of a round 2-piece top rail. The 1-piece square top rails for Systems 7 and 8 are detailed in diagram VH-38399 (see Appendix). Past testing at Intertek of this type of system showed that use of a 2-piece assembly did not allow the top rail and bottom channel to act as a composite section. The independent movement of the 2-piece top rail system decreases the lateral stiffness provided by top rail to the railing system assembly allowing greater deflection of the 2-piece top rail under equivalent loads compared to that of the 1-piece system. In addition, comparison of I_x and I_y for Systems 7 and 8 shows the 1-piece square top rail for Systems 7 and 8 exceeds the I_x and I_y of Systems 1 and 2 detailed in VS-35977A. For the reasons noted above, Systems 1 and 2 from Intertek Test Report 3155482COQ-001A and 3155482COQ-001B would meet the requirements of Section 1607.7.1 of the 2006 IBC using the 1-piece square top rails detailed in Appendix Drawing VH-38399.

5 Conclusion

Intertek has conducted an engineering evaluation for Excell Railing System, on the Excell Welded Picket & Glass Railing System and Durarail Welded Picket & Glass Railing System, to evaluate the interchangeability of 3 types of top rails. The evaluation was conducted to determine if the testing performed on the 2-piece round top rail, will show equivalency for the use of the other top rails in accordance with the 2006 IBC, Section 1607.7.1. The evaluation, as described in Section 5 of this report, shows that the following systems meet the load requirements of Section 1607.7.1 of the 2006 IBC:

- System 1 – 6 ft. Durarail 2-Piece Round Welded Picket Railing System
- System 2 – 5 ft. Durarail 2-Piece Round Glass In-fill Railing System
- System 3 – 6 ft. Durarail 2-Piece Square Welded Picket Railing System
- System 4 – 5 ft. Durarail 2-Piece Square Glass In-fill Railing System
- System 5 – 6 ft. Excell 1-Piece Round Welded Picket Railing System
- System 6 – 5 ft. Excell 1-Piece Round Glass In-fill Railing System
- System 7 – 6 ft. Excell 1-Piece Square Welded Picket Railing System
- System 8 – 5 ft. Excell 1-Piece Square Glass In-fill Railing System

INTERTEK TESTING SERVICES NA LTD.



Reported by:

Kal Kooner, EIT
Team Leader, ES Canada West

Reviewed by:

Matt Lansdowne, EIT
Team Leader, ES Canada East

ATTACHMENTS: Drawings of Durarail & Excell Railing Systems

EXCELL GLASS SYSTEM WITH 1.72" POSTS

POST MOUNT PLATE FASTENED TO 1.72" POST WITH 2x #10x1 1/2" PH SS SCREWS AND TO TOP RAIL WITH 2x #10x3/4" PH SS SCREWS

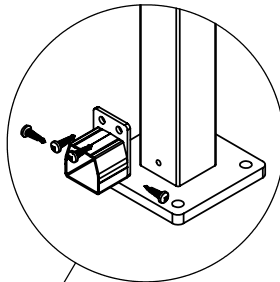
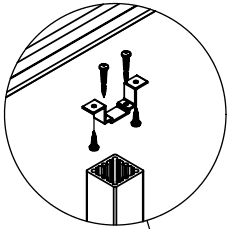

BOTTOM MOUNT FASTENED TO 1.72" POST WITH 2x #10x3/4" TEK SCREWS AND BOTTOM RAIL WITH 2x #10x3/4" TEK SCREWS

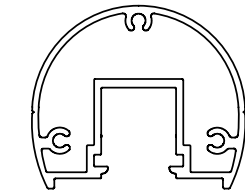

EXCELL ROUND COMPONENT GLASS TOP RAIL

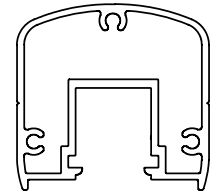

EXCELL SQUARE COMPONENT GLASS TOP RAIL

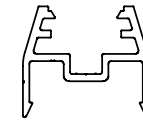

COMPONENT GLASS BOTTOM RAIL

COMPONENT GLASS SUPPORT LEG TO BE USED IN THE CENTER OF 3'-6" PANEL LENGTHS OR GREATER

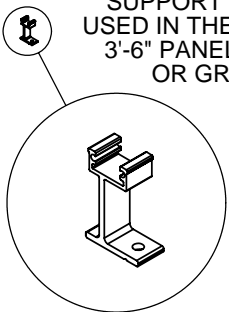

PLEASE SEE DRAWING 08-ERSL-172PST1 FOR POST ASSEMBLY DETAILS

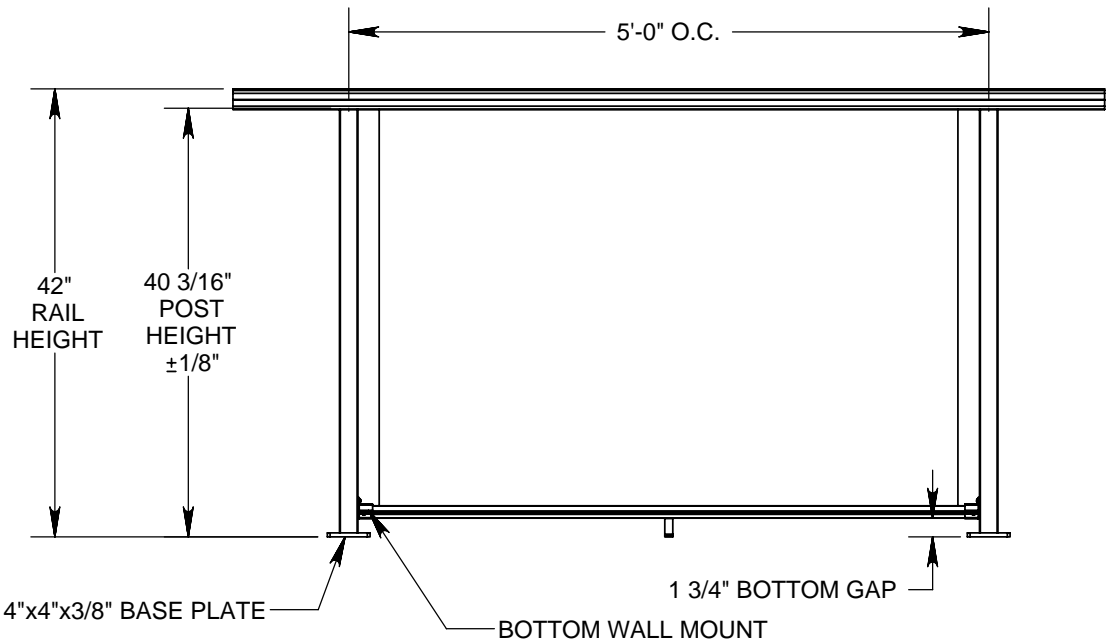

ALL DIMENSIONS ARE SUBJECT TO SITE MEASUREMENTS AND ARE TO BE CONFIRMED BEFORE FABRICATION OF PRODUCT



MANUFACTURER OF EXCELL & DURARAIL PRODUCT LINES



Authorization Signature	Date of Authorization
Excell Railing Systems Ltd. #306 - 12886 Anvil Way Surrey, BC Canada V3W 8E7 Phone: 604-501-0151 Fax: 604-501-0155 Toll Free: 1-866-999-7245 www.excellrailing.com	Durarail Kansas City Warehouse 1722 Iron Street North Kansas City, MO 64116 Toll Free: 1-800-338-3568 Fax: 1-816-421-2924 www.durarail.com

Drawing Name	08-ERSL-EGLSS1ENG1		
Customer	Excell Railing Systems Ltd.		
Project Name	Excell Glass Style 1 with 1.72 Posts (Engineer Report)		
Drawn By	Csaba Bezzegh	Date Created	July 24, 2008
Revision No.	2	Scale	NTS
		Last Update	July 31, 2008
\\Ersrv\sales\Drawing Library\Engineering\Railing Assemblies\Glass\1.72 Posts\Glass Styl e 1\Excell			